

Hi-PowerMaxx2

Installation & Operating Manual

Pump Station Battery Backup



 0330 9000 999

 info@ppspumps.com

 www.ppspumps.com

Packaged Pumps Systems Ltd.

Unit 11, Haslemere Industrial Estate, Pig Lane, Bishop's Stortford, CM23 3HG

Legal information/Copyright

All rights reserved. Contents provided herein must neither be distributed, copied, reproduced, edited or processed for any other purpose, nor otherwise transmitted, published or made available to a third party without express written consent from Packaged Pumps Systems Ltd.

Subject to technical modification without prior notice.

Contents

1.0	Hi-PowerMaxx2 overview.....	4
2.0	Box contents.....	4
3.0	Technical information.....	4
4.0	Health & Safety.....	5
5.0	Unit location.....	5
6.0	Safety.....	5
7.0	General.....	6
8.0	Wiring schematic.....	6
9.0	Wiring a standalone Hi-PowerMaxx2.....	7
10.0	Configuring the upper circuit board to the pump/s & alarm.....	8
11.0	Setup and configuration of the unit.....	8
12.0	Principals of operation.....	9
13.0	Battery life & servicing.....	9
14.0	Connecting an AlertMaxx2 or Rego1 (if purchased).....	10
15.0	MaxxConnect cabling.....	10
16.0	AlertMaxx2 wiring schematic.....	11
16.0	Rego1 wiring schematic.....	12
17.0	Wiring a MaxxConnect system.....	13
18.0	Additional error codes.....	13
19.0	Spares.....	13
20.0	Error codes (Hi-PowerMaxx2).....	14
21.0	U-Menu.....	15
22.0	Inverter check.....	15
23.0	Warranty.....	15
24.0	Packaged Pumps Systems Technical Department.....	15

1.0 Hi-PowerMaxx2 overview

The Hi-PowerMaxx2 is designed to provide battery backup to pump stations in the event of a mains failure and has been specifically designed to meet the requirements of the pump industry. The Hi-PowerMaxx2 has the ability to connect to the AlertMaxx2 high level alarm and Rego1 control panel.

2.0 Box contents

Hi-PowerMaxx2 contents

- 1 x Hi-PowerMaxx2 Unit - 5 x Batteries supplied externally
- Gland Pack (4 x Large Cable Glands, 2 x Large Blanking Plugs, 1 x Small Cable Gland, 1 x Small Blanking Plug, 4 x Large Nuts & 1 x Small Nut)
- 1 x 3m length of MaxxConnect cable
- 1 x Installation & Operating Instructions (this document)
- 1 x Chamber Location Sticker Sheet (for Spurs)

3.0 Technical information

Specification	
Product code	HiPMX2
Size (without cable glands)	475mm x 425mm x 300mm
Weight (without battery installed)	15kg
Weight (with battery installed)	80kg
Mains Supply	200–250V AC (50Hz)
Internal battery	24V - 5x22Ah = 110Ah VRLA
Power (standby)	<3W
Power (charging)	75W
Inverter	2000W P1
Visual display	2 x 7 segment
Operating temperature	5–35°C
Relative humidity	<80%
Feeds	1 or 2 (13A non-switched)
Devices	1 or 2 pumps (cannot provide together)

4.0 Health & Safety

In order to minimise the risk of ill health or accidents when installing and/or servicing pump chambers and associated accessories, workers must be fully trained and competent. The following guidelines will help safeguard matters:

- Assessing the risk and working in accordance with the control measures identified.
- Ensure electrical power to the equipment is isolated before carrying out installation or maintenance.
- A suitable first aid kit must be close to hand.
- The electrical installation must comply with the requirements of BS 7671:2018 'Requirements for Electrical Installations' incorporating the latest amendment.

5.0 Unit location

The unit must be positioned where there is sufficient air circulation to all the vents and is permanently accessible for servicing. If using in conjunction with an AlertMaxx2 high level alarm or Rego1, please ensure the units are no further than a 20m cable length from each other.

MaxxConnect cable can be purchased per 10m (CAS-MCC-01). **Do not join cables. Run full lengths only.**

CAUTION!

The unit is IP2X and is not waterproof, it must be installed indoors or inside a kiosk. The unit must also be installed in a chemically neutral environment with a relative humidity of <80% and a maximum temperature of 35°C. It is recommended that the unit is installed off the floor.

Installations not following this guidance will void the manufacturer's guarantee.

CAUTION!

This product should only be installed by qualified personnel in accordance with the latest regulations.

6.0 Safety

The unit has 240V present at all times and can generate dangerous voltage even if the mains supply is cut. The black power switch only disables the ability to generate 240V from the battery pack; however, mains feeds are still live and present supplying the pumps. To be completely safe, remove the fuses from both spurs, ensure the unit is switched off and disconnect the battery pack.

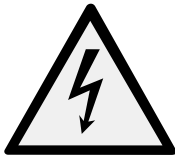

240 Volts present at all times Risk of voltage backfeed

Isolate mains & disconnect battery before working on the circuitry connected to this unit or the unit itself.
Do not rely on measuring values.
To be serviced by a certified electrician only.

Battery Type: Lead-acid Battery Specification: 24V DC 22Ah Caution: Replace with same type only

Risk of electric shock & chemical hazard.

Refer to the instruction manual for handling, disposal & maintenance information.



7.0 General

The Hi-PowerMaxx2 can supply one or two pumps (not simultaneously) and has been certified for use on:

- V4 & V6

The supplies to the pump/s should be separately fused using non-switched fused spurs and not on the same ring mains.

8.0 Wiring schematic

The below wiring schematic shows a typical installation using a Hi-PowerMaxx2 and Dual V6 pump station.

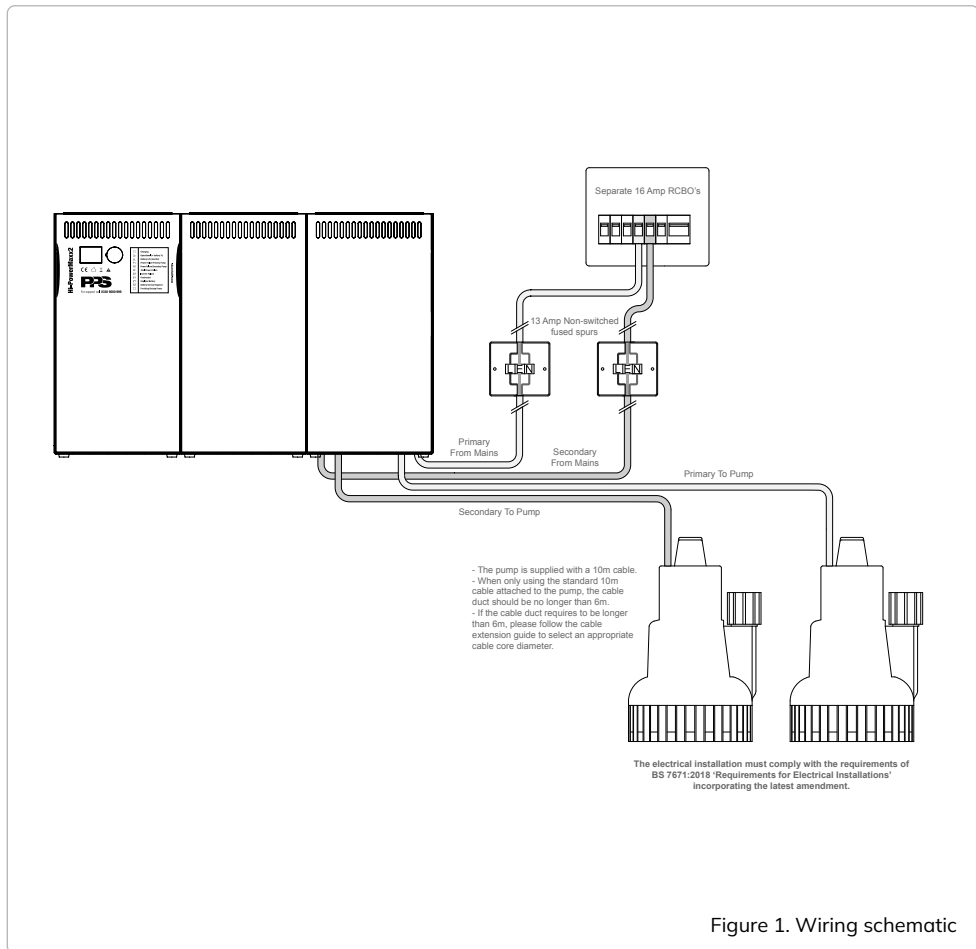

Figure 1. Wiring schematic

9.0 Wiring a standalone Hi-PowerMaxx2

1. Remove the fuses from the spurs that will power the pumps being used with the Hi-PowerMaxx2.
2. Ensure the power switch of the Hi-PowerMaxx2 is in the OFF position.
3. Remove the Hi-PowerMaxx2 lid and place in front of the unit - **take care not to damage the cables.**
4. Remove the side panels and position the Hi-PowerMaxx2 in the chosen location for installation.
5. If you are configuring the unit with **one pump**, fit two large cable glands into the primary side of the unit and two blanking plugs into the secondary side of the unit.
If you are configuring the unit with **two pumps**, fit two large cable glands into the primary side of the unit and two large cable glands into the secondary side of the unit.
If you are connecting an **AlertMaxx2**, fit a small cable gland into the small hole above the secondary holes.
6. Using the cable glands on the back of the Hi-PowerMaxx2, feed the power and pump cables through to the correct terminal blocks on the lower circuit board.
There are two connector blocks on the lower circuit board: **PRIMARY** and **SECONDARY**.
The primary connector block should always have a connection as this is the supply that charges the Hi-PowerMaxx2.
7. Connect the supply to the 'From Mains' and the corresponding pump to the 'To Pump' (figure 2).
8. Install all five batteries into the battery trays so that the grey Anderson connectors face into the centre of the Hi-PowerMaxx2. Plug each **RED** Anderson connector attached to the extended six arm cable to each **GREY** Anderson connector on the five batteries installed in the unit and one to the connector from PCB1. The batteries have **GREY** Anderson connectors and the harness has **RED** Anderson connectors. **The following configuration is ONLY acceptable - RED to GREY connectors.**
9. Tuck the grey Anderson connectors and cables into the void between the batteries.

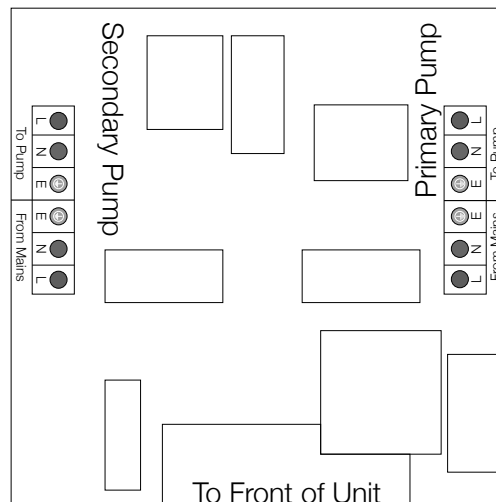

Figure 2. Wiring the lower circuit board - Hi-PowerMaxx2

10.0 Configuring the upper circuit board to the pump/s & alarm

Using the diagram on the right, set the switches on the upper circuit board according to your systems configuration (figure 3).

When wiring in series with a Rego1 always set the pump switch to the '1 pump' position.

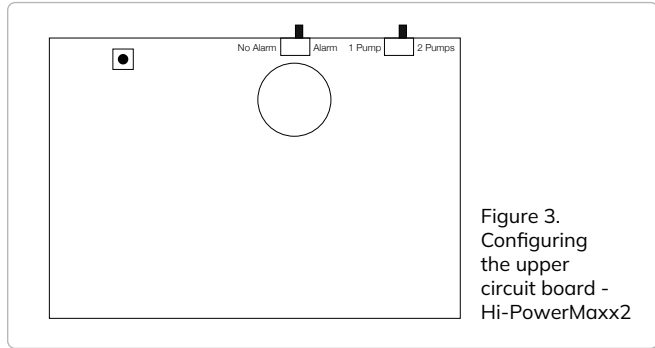

Figure 3. Configuring the upper circuit board - Hi-PowerMaxx2

11.0 Setup and configuration of the unit

1. Replace the side panels of the unit, followed by the lid.
2. Replace the fuses to the spurs supplying the unit and turn on the mains power.
3. Check that the pump/s are receiving power (**with the unit switched off**) by lifting the float arms on the pump/s.
4. Switch the unit on; the screen will display a left to right start up sequence, followed by the software release.
5. A C0 will show on the display while the unit checks the environment and the connections. C0 will be present for approximately 10-15 seconds.
6. If the unit passes the initial config, a CC will be shown on the display and then the unit will restart and show -- followed by On and then flip between the charging bars and the -- while the unit calculates the battery percentage (this can take up to 3 minutes). Once the unit has calculated the battery percent, it will stop displaying -- and show a figure from 0-99% depending on the state of the battery.
7. If the unit fails to configure correctly (error code below) - switch the unit off, remove the fuses from the spurs, remove the side panels and lid, redo the connections or set the configuration switches to the correct positions and then replace the covers and turn the unit back on. If the issue still persists, please call technical support on 0330 9000 999.
8. **If you are connecting an AlertMaxx2 or Rego, please refer to section 14.0 of this manual.**

Code	During initial configuration
C0	Config started.
C1	No primary mains present. Check supply.
C2	No secondary mains present. Check supply.
C3	No battery connected. Connect battery.
C4	Primary mains 'in' and pump 'out' swapped. Swap over wiring.
C5	Secondary mains 'in' and pump 'out' swapped. Swap over wiring.
C6	Pump switch in '1P', but 2 mains 'in' detected. Change switch to correct setting.

12.0 Principals of operation

Normal operation

In normal operation, the power bypasses the unit which acts as a junction box, and this then feeds the pumps directly. Pump supply #1 (primary) also charges the battery.

Backup operation

When the unit senses that the power is down, the unit enters backup mode. To save power, the battery backup will periodically and dynamically test if the pump/s need power (float up) using a system called DyPol (from 10-180 seconds depending on how often the pumps are cycling). If the pump/s need power, it will serve the pump requesting power for as long as needed or until the battery is depleted.

If two pumps are connected and both supplies have failed it will serve both pumps in a rotational manner giving equal priority until the power returns or the battery backup is depleted.

If the secondary power has failed, it will serve the secondary pump as required from the battery. However, it will also charge the battery from the primary spur, when the secondary pump does not need power.

Charging

After any power failure, the battery is always charged. The battery is also charged and topped up every 21 days. This process can take up to 25 hours for a Hi-PowerMaxx2 to fully charge an empty battery.

13.0 Battery life & servicing

The battery has a nominal life span of 3 years and is displayed on the unit with a bL+36. This life span is shortened over time and also by the following:

- Temperatures above 25°C.
- The number of discharges (the number of times the unit has been used without mains power).
- The depletion level when discharging and the number of times the batteries are used. Extended periods providing backup power will impact battery life.

Replacement of the battery pack should be done every 2-3 years to ensure the maximum backup time. In some cases, the battery may need earlier replacement. This will be indicated by an S2 on the Hi-PowerMaxx2. Servicing of the battery pack should be performed by a qualified service person with knowledge about batteries and the required precautions. The battery pack should be replaced with the same type the unit is installed with. This information can be found within the unit or on page 5.

WARNING!

Do not dispose of batteries in a fire. The batteries may explode.
Do not dispose of batteries in landfill. Please recycle safely at your local recycling plant.
Do not open or damage batteries. Released electrolyte is harmful to the skin and eyes and may be toxic.

- To reset the S2, see section 21.0 - U6.

Please note, the battery service reset should only be performed by qualified personnel and only when the battery has been changed. It is the owner's responsibility to ensure the battery is replaced when required. If the battery is not changed when required, the unit will not be able to backup the pumps according to the specification and in some instances, not at all.

14.0 Connecting an AlertMaxx2 or Rego1 (if purchased)

The Hi-PowerMaxx2 can be connected to an AlertMaxx2 or Rego1. Battery backup capacity and condition are fed directly to the SideWinder Tech software when connected to the internet.

The Hi-PowerMaxx2 is supplied with 3m of 4 core MaxxConnect family cable.

15.0 MaxxConnect cabling

The units are to be a maximum of 20m cable distance apart. MaxxConnect cable can be purchased per 10m (CAS-MCC-01). **Do not join cables. Run full lengths only.**

PLEASE NOTE

The AlertMaxx2 must have the pump/s wired into it. The AlertMaxx2 must be installed in series with the Hi-PowerMaxx2, this means the AlertMaxx2 must be installed in between the Hi-PowerMaxx2 & the pump/s as per figure 5 on page 12.

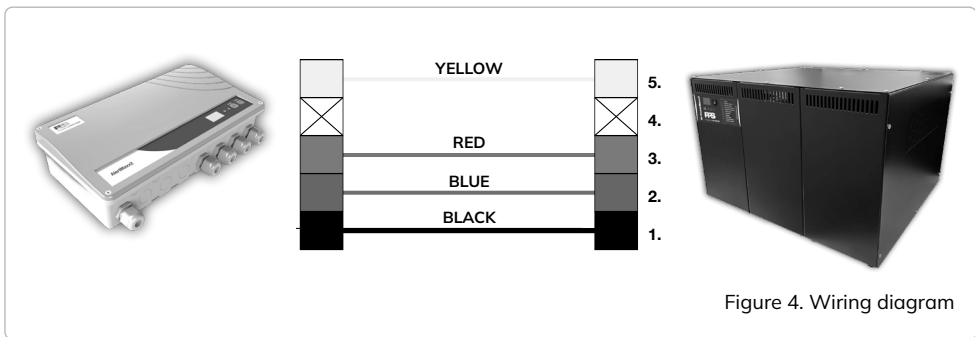

16.0 AlertMaxx2 wiring schematic

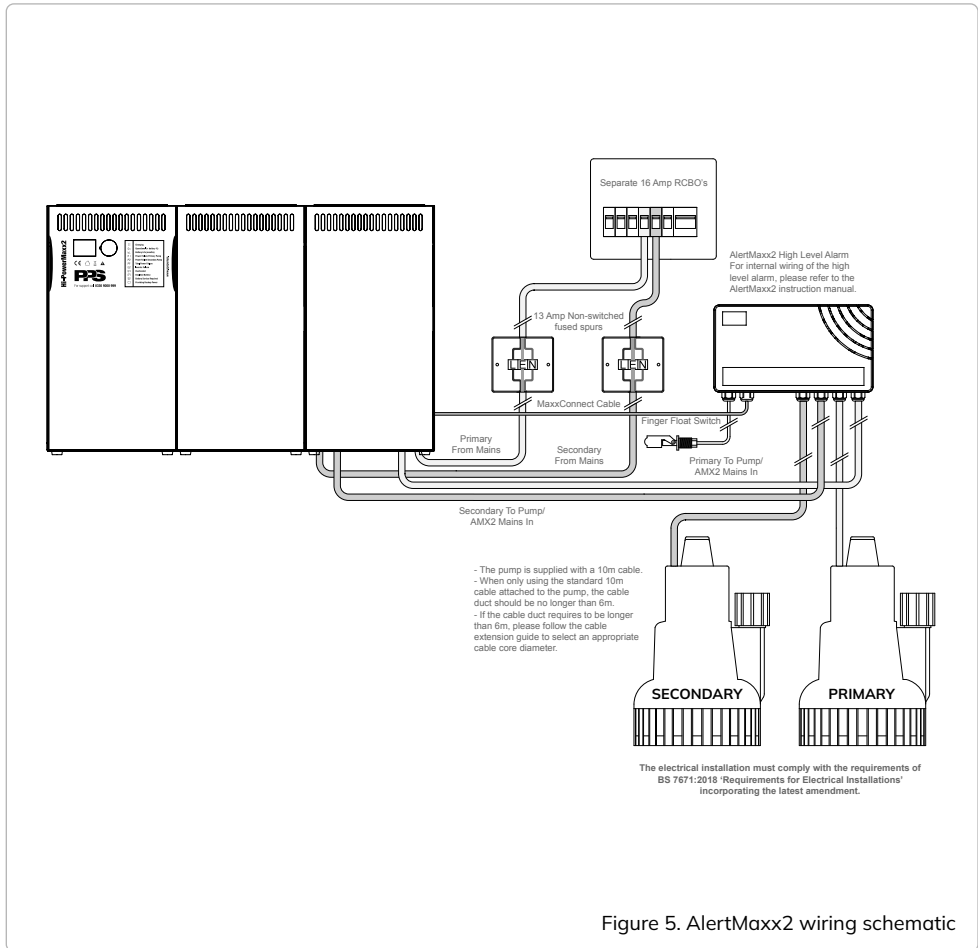

Figure 5. AlertMaxx2 wiring schematic

16.0 Rego1 wiring schematic

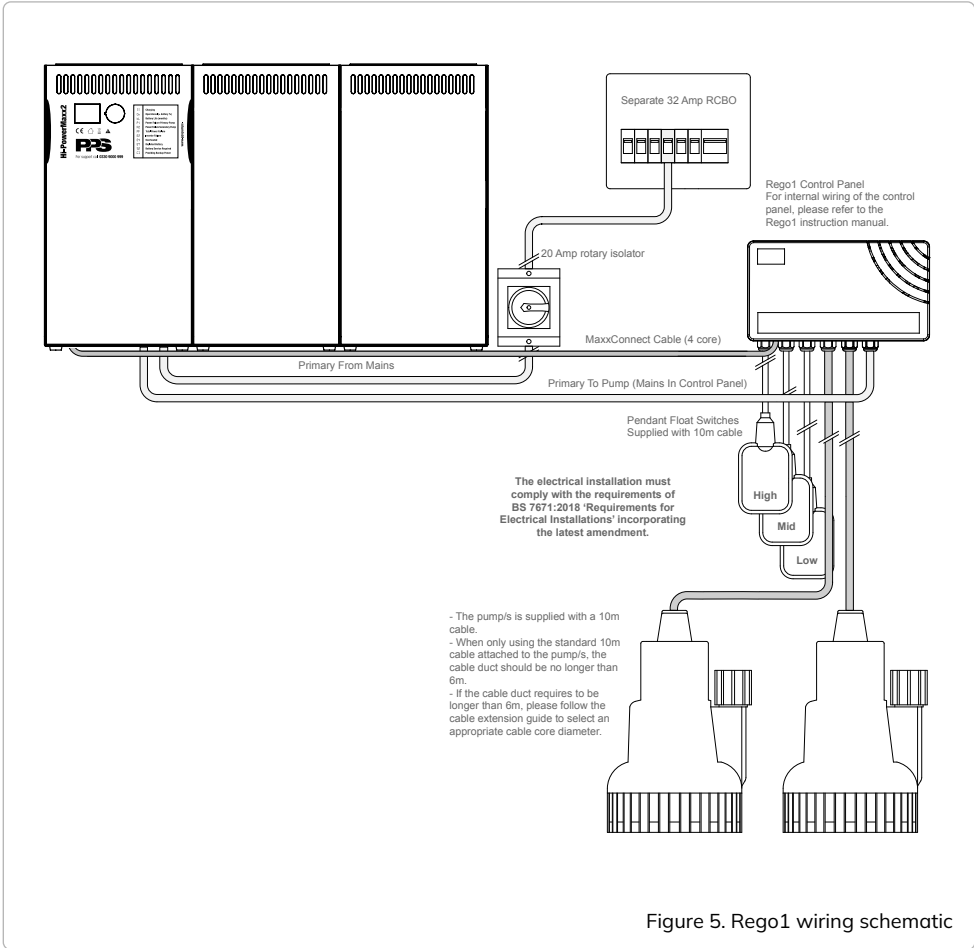

Figure 5. Rego1 wiring schematic

17.0 Wiring a MaxxConnect system

1. Install the AlertMaxx2 or Rego1 and battery backup as per the wiring schematic on page 12.
Leave isolated and turned off.
2. Wire in the MaxxConnect cable according to the wiring schematic on page 12.
3. Configure the switches as per section 10.0.
4. Reconnect the batteries in the battery backup and AlertMaxx2/Rego1.
5. Refit the fascia/covers and power on the mains and units.
6. The battery backup should now startup with a flashing decimal point indicating it is trying to find the AlertMaxx2/Rego1. This could take up to 2 minutes to clear.

CAUTION!

MaxxConnect misconnections will destroy one or all connected units (this can be detected by the manufacturer) and void the guarantee.

18.0 Additional error codes

The MaxxConnect introduces two new error codes to the Hi-PowerMaxx2 and one new error code to the AlertMaxx2/Rego1:

1. Hi-PowerMaxx2 - flashing decimal point - Trying to find the AlertMaxx2/Rego1
2. Hi-PowerMaxx2 - E5 - Cannot find the AlertMaxx2/Rego1
3. AlertMaxx2/Rego1 - E5 - Cannot find battery backup

If the mains power fails, the AlertMaxx2 and Rego1 will keep themselves operating and charging from the battery backup. Please note, this will reduce the resilience of the battery backup.

19.0 Spares

Part No.	Description
CAS-B24V-01	24V Battery Pack
CAS-MCC-01	MaxxConnect cable extension - sold per 10m

20.0 Error codes

Code	Fault
E2	Inverter failure. Call support 0330 9000 999.
E3	Charger error. Call support 0330 9000 999.
E5	Cannot detect an AlertMaxx2 or Rego1. Can be intermittent, will usually resolve.
E7	Depleted battery or disconnected. Activate mains power or connect the battery.
E8	Serious software error. Call support 0330 9000 999.
EE	Empty U-menu slot
S2	Battery replacement required. Call support 0330 9000 999.
P1 + %	Power failure on primary pump + battery %
P2 + %	Power failure on secondary pump + battery %
PF + %	Total power failure + battery %
On+%+bL+month	Unit operational + battery % + battery life in months (normal operation)
:: :: ::	Unit charging + battery %
Snake pattern	Unit providing power to pump (only shown during power failure and providing)

21.0 U-Menu

The Hi-PowerMaxx2 has a number of service routines (U-Menu) which can be used for various functions (as detailed below). The U-Menu can be accessed by pressing and holding the button at the top of the upper PCB. Release the button on the chosen U-Menu slot.

PLEASE NOTE

The upper PCB is capable of producing 12V. Ensure you press only the button.

U-Menu Slot	Function
U1	Shows the live running current of each connected pump. Press again to clear or will time out automatically.
U5	Shows the total time that the Hi-PowerMaxx2 has provided backup power (showing in minutes). Press again to clear or will time out automatically.
U6	Used to reset the S2 battery indicator back to 3 years (36 months). After releasing on U6, bL will show on the display. Press and hold the button until OH appears on the screen, the OH will clear and the unit will display On or the charging bars.

22.0 Inverter check

The inverter in the Hi-PowerMaxx2 will initiate a self-check after the initial config stage and then periodically. This is implemented in the software to ensure the inverter operates correctly and will provide power to the pump when needed.

23.0 Warranty

The Hi-PowerMaxx2 is offered with a 24 month component warranty. This warranty only covers any defects in workmanship, construction or material. This warranty does not cover, defects caused by incorrect installation, installer error, abnormal working conditions, misuse or neglect.

22.0 Packaged Pumps Systems Technical Department

If you are experiencing any technical issues, please contact the Packaged Pumps Systems Technical department on **0300 9000 999** from 9:00am - 5:00pm or email info@ppspumps.com.

 0330 9000 999

 info@ppspumps.com

 www.ppspumps.com

Packaged Pumps Systems Ltd.
Unit 11, Haslemere Industrial Estate, Pig Lane, Bishop's Stortford, CM23 3HG